

THE PROPERTY OF THE DRAWING IS ESTABLISHED BY LAW. IT IS FORBIDDEN TO PRODUCE OR SHOW IT TO THIRD PARTY, WITHOUT A WRITTEN AGREEMENT.

Item	Name	Q. ty
1	EPL.25.270	1
2	R.5	4
3	V.TCE5x12	4

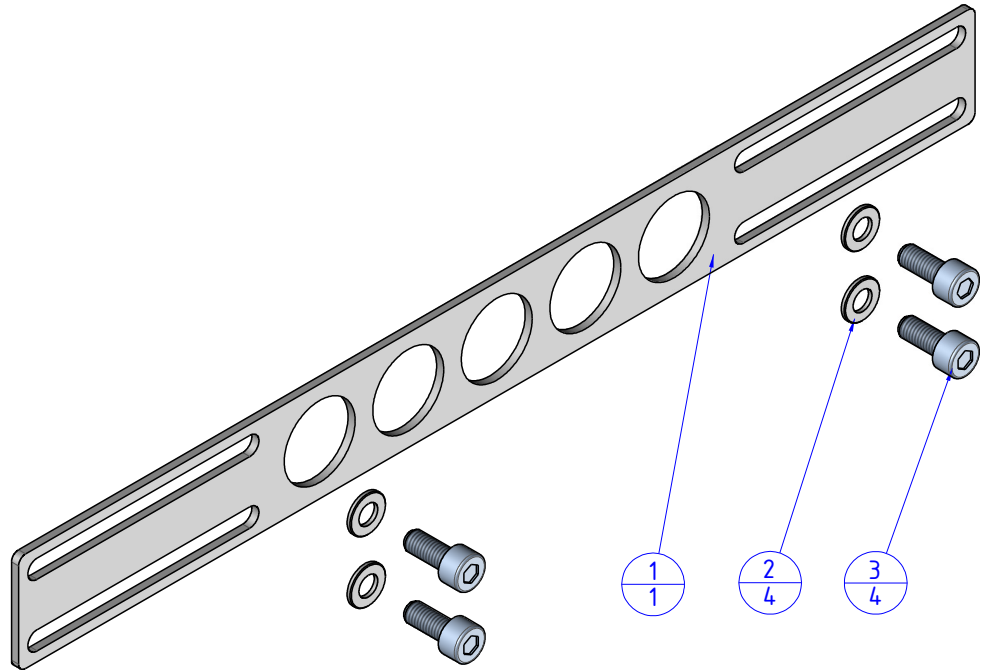
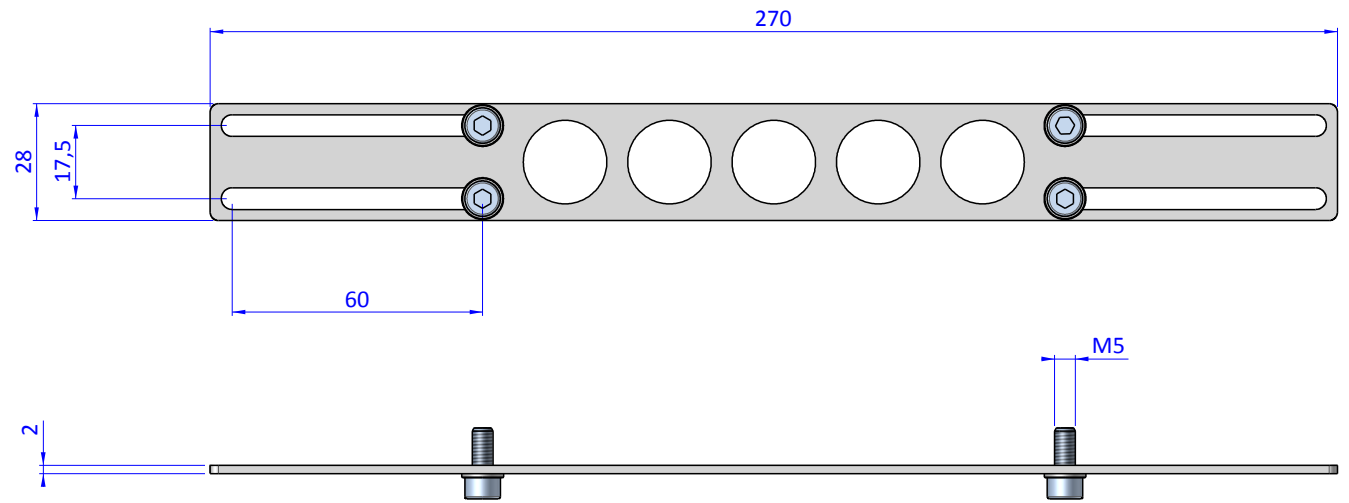

Format A3

UNI 936-76

FP SERVICES AUTOMATION		DESIGNED FROM FPSERVICES		REVIEW A / 11
GENERAL TOLERANCE UNI - ISO 2768 CLASSE f	DESCRIPTION CA.EPL.25.270	DATE 19/09/2018	WEIGHT 0,091kg	CODE CA.EPL.25.270